

Week8 monday

Theorem: A_{TM} is not Turing-decidable.

Proof: Suppose **towards a contradiction** that there is a Turing machine that decides A_{TM} . We call this presumed machine M_{ATM} .

By assumption, for every Turing machine M and every string w

- If $w \in L(M)$, then the computation of M_{ATM} on $\langle M, w \rangle$ _____
- If $w \notin L(M)$, then the computation of M_{ATM} on $\langle M, w \rangle$ _____

Define a **new** Turing machine using the high-level description:

$D =$ “ On input $\langle M \rangle$, where M is a Turing machine:

1. Run M_{ATM} on $\langle M, \langle M \rangle \rangle$.
2. If M_{ATM} accepts, reject; if M_{ATM} rejects, accept.”

Is D a Turing machine?

Is D a decider?

What is the result of the computation of D on $\langle D \rangle$?

Theorem (Sipser Theorem 4.22): A language is Turing-decidable if and only if both it and its complement are Turing-recognizable.

Proof, first direction: Suppose language L is Turing-decidable. WTS that both it and its complement are Turing-recognizable.

Proof, second direction: Suppose language L is Turing-recognizable, and so is its complement. WTS that L is Turing-decidable.

Give an example of a **decidable** set:

Give an example of a **recognizable undecidable** set:

Give an example of an **unrecognizable** set:

True or False: The class of Turing-decidable languages is closed under complementation?

Definition: A language L over an alphabet Σ is called **co-recognizable** if its complement, defined as $\Sigma^* \setminus L = \{x \in \Sigma^* \mid x \notin L\}$, is Turing-recognizable.

Notation: The complement of a set X is denoted with a superscript c , X^c , or an overline, \overline{X} .

Week5 monday

To fully specify a PDA we could give its 6-tuple formal definition or we could give its input alphabet, stack alphabet, and state diagram. An informal description of a PDA is a step-by-step description of how its computations would process input strings; the reader should be able to reconstruct the state diagram or formal definition precisely from such a description. The informal description of a PDA can refer to some common modules or subroutines that are computable by PDAs:

- PDAs can “test for emptiness of stack” without providing details. *How?* We can always push a special end-of-stack symbol, \$, at the start, before processing any input, and then use this symbol as a flag.
- PDAs can “test for end of input” without providing details. *How?* We can transform a PDA to one where accepting states are only those reachable when there are no more input symbols.

Big picture: PDAs were motivated by wanting to add some memory of unbounded size to NFA. How do we accomplish a similar enhancement of regular expressions to get a syntactic model that is more expressive?

DFA, NFA, PDA: Machines process one input string at a time; the computation of a machine on its input string reads the input from left to right.

Regular expressions: Syntactic descriptions of all strings that match a particular pattern; the language described by a regular expression is built up recursively according to the expression’s syntax

Context-free grammars: Rules to produce one string at a time, adding characters from the middle, beginning, or end of the final string as the derivation proceeds.

Term	Typical symbol	Definition
Context-free grammar (CFG)	G	$G = (V, \Sigma, R, S)$
Variables	V	Finite set of symbols that represent phases in production pattern
Terminals	Σ	Alphabet of symbols of strings generated by CFG $V \cap \Sigma = \emptyset$
Rules	R	Each rule is $A \rightarrow u$ with $A \in V$ and $u \in (V \cup \Sigma)^*$
Start variable	S	Usually on LHS of first / topmost rule
Derivation	$S \Rightarrow \dots \Rightarrow w$	Sequence of substitutions in a CFG Start with start variable, apply one rule to one occurrence of a variable at a time
Language generated by the CFG G	$L(G)$	$\{w \in \Sigma^* \mid \text{there is derivation in } G \text{ that ends in } w\} = \{w \in \Sigma^* \mid S \Rightarrow^* w\}$
Context-free language		A language that is the language generated by some CFG
Sipser pages 102-103		

Examples of context-free grammars, derivations in those grammars, and the languages generated by those grammars

$G_1 = (\{S\}, \{0\}, R, S)$ with rules

$$S \rightarrow 0S$$

$$S \rightarrow 0$$

In $L(G_1) \dots$

Not in $L(G_1) \dots$

$G_2 = (\{S\}, \{0, 1\}, R, S)$

$$S \rightarrow 0S \mid 1S \mid \varepsilon$$

In $L(G_2) \dots$

Not in $L(G_2) \dots$

$(\{S, T\}, \{0, 1\}, R, S)$ with rules

$$S \rightarrow T1T1T1T$$

$$T \rightarrow 0T \mid 1T \mid \varepsilon$$

In $L(G_3)$...

Not in $L(G_3)$...

$G_4 = (\{A, B\}, \{0, 1\}, R, A)$ with rules

$$A \rightarrow 0A0 \mid 0A1 \mid 1A0 \mid 1A1 \mid 1$$

In $L(G_4)$...

Not in $L(G_4)$...

Extra practice: Is there a CFG G with $L(G) = \emptyset$?

Design a CFG to generate the language $\{abba\}$

$(\{S, T, V, W\}, \{a, b\}, \{S \rightarrow aT, T \rightarrow bV, V \rightarrow bW, W \rightarrow a\}, S)$

$(\{Q\}, \{a, b\}, \{Q \rightarrow abba\}, Q)$

$(\{X, Y\}, \{a, b\}, \{X \rightarrow aYa, Y \rightarrow bb\}, X)$

Design a CFG to generate the language $\{a^n b^n \mid n \geq 0\}$

Sample derivation:

Design a CFG to generate the language $\{a^i b^j \mid j \geq i \geq 0\}$

Sample derivation:

Week5 wednesday

Theorem 2.20: A language is generated by some context-free grammar if and only if it is recognized by some push-down automaton.

Definition: a language is called **context-free** if it is the language generated by a context-free grammar. The class of all context-free language over a given alphabet Σ is called **CFL**.

Consequences:

- Quick proof that every regular language is context free
- To prove closure of the class of context-free languages under a given operation, we can choose either of two modes of proof (via CFGs or PDAs) depending on which is easier

Over $\Sigma = \{a, b\}$, let $L = \{a^n b^m \mid n \neq m\}$. **Goal:** Prove L is context-free.

Suppose L_1 and L_2 are context-free languages over Σ . **Goal:** $L_1 \cup L_2$ is also context-free.

Approach 1: with PDAs

Let $M_1 = (Q_1, \Sigma, \Gamma_1, \delta_1, q_1, F_1)$ and $M_2 = (Q_2, \Sigma, \Gamma_2, \delta_2, q_2, F_2)$ be PDAs with $L(M_1) = L_1$ and $L(M_2) = L_2$.

Define $M =$

Approach 2: with CFGs

Let $G_1 = (V_1, \Sigma, R_1, S_1)$ and $G_2 = (V_2, \Sigma, R_2, S_2)$ be CFGs with $L(G_1) = L_1$ and $L(G_2) = L_2$.

Define $G =$

Suppose L_1 and L_2 are context-free languages over Σ . **Goal:** $L_1 \circ L_2$ is also context-free.

Approach 1: with PDAs

Let $M_1 = (Q_1, \Sigma, \Gamma_1, \delta_1, q_1, F_1)$ and $M_2 = (Q_2, \Sigma, \Gamma_2, \delta_2, q_2, F_2)$ be PDAs with $L(M_1) = L_1$ and $L(M_2) = L_2$.

Define $M =$

Approach 2: with CFGs

Let $G_1 = (V_1, \Sigma, R_1, S_1)$ and $G_2 = (V_2, \Sigma, R_2, S_2)$ be CFGs with $L(G_1) = L_1$ and $L(G_2) = L_2$.

Define $G =$

Summary

Over a fixed alphabet Σ , a language L is **regular**

- iff it is described by some regular expression
- iff it is recognized by some DFA
- iff it is recognized by some NFA

Over a fixed alphabet Σ , a language L is **context-free**

- iff it is generated by some CFG
- iff it is recognized by some PDA

Fact: Every regular language is a context-free language.

Fact: There are context-free languages that are not nonregular.

Fact: There are countably many regular languages.

Fact: There are countably infinitely many context-free languages.

Consequence: Most languages are **not** context-free!

Examples of non-context-free languages

$$\begin{aligned} &\{a^n b^n c^n \mid 0 \leq n, n \in \mathbb{Z}\} \\ &\{a^i b^j c^k \mid 0 \leq i \leq j \leq k, i \in \mathbb{Z}, j \in \mathbb{Z}, k \in \mathbb{Z}\} \\ &\{ww \mid w \in \{0, 1\}^*\} \end{aligned}$$

(Sipser Ex 2.36, Ex 2.37, 2.38)

There is a Pumping Lemma for CFL that can be used to prove a specific language is non-context-free: If A is a context-free language, there there is a number p where, if s is any string in A of length at least p , then s may be divided into five pieces $s = uvxyz$ where (1) for each $i \geq 0$, $uv^i xy^i z \in A$, (2) $|uv| > 0$, (3) $|vxy| \leq p$. *We will not go into the details of the proof or application of Pumping Lemma for CFLs this quarter.*

Week5 friday

A set X is said to be **closed** under an operation OP if, for any elements in X , applying OP to them gives an element in X .

True/False	Closure claim
True	The set of integers is closed under multiplication. $\forall x \forall y ((x \in \mathbb{Z} \wedge y \in \mathbb{Z}) \rightarrow xy \in \mathbb{Z})$
True	For each set A , the power set of A is closed under intersection. $\forall A_1 \forall A_2 ((A_1 \in \mathcal{P}(A) \wedge A_2 \in \mathcal{P}(A) \in \mathbb{Z}) \rightarrow A_1 \cap A_2 \in \mathcal{P}(A))$
	The class of regular languages over Σ is closed under complementation.
	The class of regular languages over Σ is closed under union.
	The class of regular languages over Σ is closed under intersection.
	The class of regular languages over Σ is closed under concatenation.
	The class of regular languages over Σ is closed under Kleene star.
	The class of context-free languages over Σ is closed under complementation.
	The class of context-free languages over Σ is closed under union.
	The class of context-free languages over Σ is closed under intersection.
	The class of context-free languages over Σ is closed under concatenation.
	The class of context-free languages over Σ is closed under Kleene star.

Assume $\Sigma = \{0, 1, \#\}$

Σ^*	Regular	/	nonregular and context-free	/	not context-free
$\{0^i \# 1^j \mid i \geq 0, j \geq 0\}$	Regular	/	nonregular and context-free	/	not context-free
$\{0^i 1^j \# 1^j 0^i \mid i \geq 0, j \geq 0\}$	Regular	/	nonregular and context-free	/	not context-free
$\{0^i 1^j \# 0^i 1^j \mid i \geq 0, j \geq 0\}$	Regular	/	nonregular and context-free	/	not context-free

Turing machines: unlimited read + write memory, unlimited time (computation can proceed without “consuming” input and can re-read symbols of input)

- Division between program (CPU, state diagram) and data
- Unbounded memory gives theoretical limit to what modern computation (including PCs, supercomputers, quantum computers) can achieve
- State diagram formulation is simple enough to reason about (and diagonalize against) while expressive enough to capture modern computation

For Turing machine $M = (Q, \Sigma, \Gamma, \delta, q_0, q_{accept}, q_{reject})$ the **computation** of M on a string w over Σ is:

- Read/write head starts at leftmost position on tape.
- Input string is written on $|w|$ -many leftmost cells of tape, rest of the tape cells have the blank symbol. **Tape alphabet** is Γ with $\sqcup \in \Gamma$ and $\Sigma \subseteq \Gamma$. The blank symbol $\sqcup \notin \Sigma$.
- Given current state of machine and current symbol being read at the tape head, the machine transitions to next state, writes a symbol to the current position of the tape head (overwriting existing symbol), and moves the tape head L or R (if possible). Formally, **transition function** is

$$\delta : Q \times \Gamma \rightarrow Q \times \Gamma \times \{L, R\}$$

- Computation ends if and when machine enters either the accept or the reject state. This is called **halting**. Note: $q_{accept} \neq q_{reject}$.

The **language recognized by the Turing machine** M , is

$$\{w \in \Sigma^* \mid \text{computation of } M \text{ on } w \text{ halts after entering the accept state}\} = \{w \in \Sigma^* \mid w \text{ is accepted by } M\}$$

An example Turing machine: $\Sigma =$

, $\Gamma =$

$\delta((q_0, 0)) =$

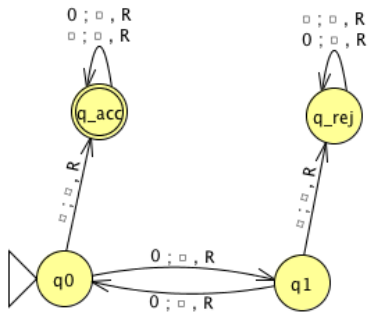

Formal definition:

Sample computation:

$q_0 \downarrow$						
0	0	0	␣	␣	␣	␣

The language recognized by this machine is ...

Extra practice:

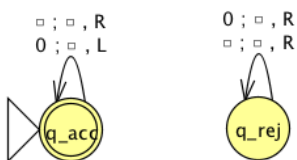

Formal definition:

Sample computation:

Week4 monday

Recap so far: In DFA, the only memory available is in the states. Automata can only “remember” finitely far in the past and finitely much information, because they can have only finitely many states. If a computation path of a DFA visits the same state more than once, the machine can’t tell the difference between the first time and future times it visits this state. Thus, if a DFA accepts one long string, then it must accept (infinitely) many similar strings.

Definition A positive integer p is a **pumping length** of a language L over Σ means that, for each string $s \in \Sigma^*$, if $|s| \geq p$ and $s \in L$, then there are strings x, y, z such that

$$s = xyz$$

and

$$|y| > 0, \quad \text{for each } i \geq 0, xy^iz \in L, \quad \text{and} \quad |xy| \leq p.$$

Negation: A positive integer p is **not a pumping length** of a language L over Σ iff

$$\exists s (|s| \geq p \wedge s \in L \wedge \forall x \forall y \forall z ((s = xyz \wedge |y| > 0 \wedge |xy| \leq p) \rightarrow \exists i (i \geq 0 \wedge xy^iz \notin L)))$$

Informally:

Restating **Pumping Lemma**: If L is a regular language, then it has a pumping length.

Contrapositive: If L has no pumping length, then it is nonregular.

The Pumping Lemma *cannot* be used to prove that a language *is* regular.

The Pumping Lemma **can** be used to prove that a language *is not* regular.

Extra practice: Exercise 1.49 in the book.

Proof strategy: To prove that a language L is **not** regular,

- Consider an arbitrary positive integer p
- Prove that p is not a pumping length for L
- Conclude that L does not have *any* pumping length, and therefore it is not regular.

Example: $\Sigma = \{0, 1\}$, $L = \{0^n 1^n \mid n \geq 0\}$.

Fix p an arbitrary positive integer. List strings that are in L and have length greater than or equal to p :

Pick $s =$

Suppose $s = xyz$ with $|xy| \leq p$ and $|y| > 0$.

Then when $i =$ _____, $xy^i z =$

Example: $\Sigma = \{0, 1\}$, $L = \{ww^R \mid w \in \{0, 1\}^*\}$.

Fix p an arbitrary positive integer. List strings that are in L and have length greater than or equal to p :

Pick $s =$

Suppose $s = xyz$ with $|xy| \leq p$ and $|y| > 0$.

Then when $i =$, $xy^iz =$

Example: $\Sigma = \{0, 1\}$, $L = \{0^j1^k \mid j \geq k \geq 0\}$.

Fix p an arbitrary positive integer. List strings that are in L and have length greater than or equal to p :

Pick $s =$

Suppose $s = xyz$ with $|xy| \leq p$ and $|y| > 0$.

Then when $i =$, $xy^iz =$

Example: $\Sigma = \{0, 1\}$, $L = \{0^n1^m0^n \mid m, n \geq 0\}$.

Fix p an arbitrary positive integer. List strings that are in L and have length greater than or equal to p :

Pick $s =$

Suppose $s = xyz$ with $|xy| \leq p$ and $|y| > 0$.

Then when $i =$, $xy^iz =$

Week4 friday

Definition A **pushdown automaton** (PDA) is specified by a 6-tuple $(Q, \Sigma, \Gamma, \delta, q_0, F)$ where Q is the finite set of states, Σ is the input alphabet, Γ is the stack alphabet,

$$\delta : Q \times \Sigma_\epsilon \times \Gamma_\epsilon \rightarrow \mathcal{P}(Q \times \Gamma_\epsilon)$$

is the transition function, $q_0 \in Q$ is the start state, $F \subseteq Q$ is the set of accept states.

Formal definition

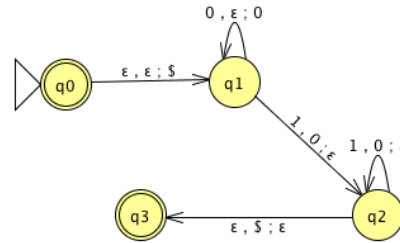

Draw the state diagram of a PDA with $\Sigma = \Gamma$.

Draw the state diagram of a PDA with $\Sigma \cap \Gamma = \emptyset$.

A PDA recognizing the set { } can be informally described as:

Read symbols from the input. As each 0 is read, push it onto the stack. As soon as 1s are seen, pop a 0 off the stack for each 1 read. If the stack becomes empty and there is exactly one 1 left to read, read that 1 and accept the input. If the stack becomes empty and there are either zero or more than one 1s left to read, or if the 1s are finished while the stack still contains 0s, or if any 0s appear in the input following 1s, reject the input.

State diagram for this PDA:

Consider the state diagram of a PDA with input alphabet Σ and stack alphabet Γ .

Label	means
$a, b; c$ when $a \in \Sigma, b \in \Gamma, c \in \Gamma$	
$a, \varepsilon; c$ when $a \in \Sigma, c \in \Gamma$	
$a, b; \varepsilon$ when $a \in \Sigma, b \in \Gamma$	
$a, \varepsilon; \varepsilon$ when $a \in \Sigma$	

How does the meaning change if a is replaced by ε ?

Note: alternate notation is to replace ; with \rightarrow

For the PDA state diagrams below, $\Sigma = \{0, 1\}$.

Mathematical description of language

State diagram of PDA recognizing language

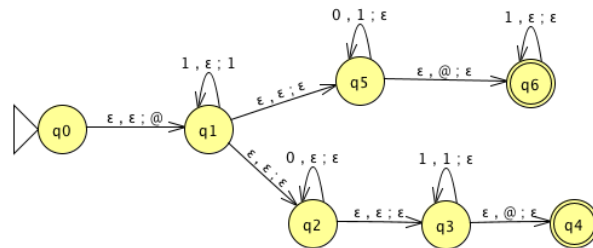
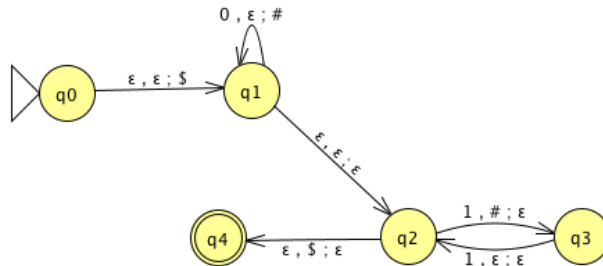

$$\{0^i 1^j 0^k \mid i, j, k \geq 0\}$$

Week6 monday

For Turing machine $M = (Q, \Sigma, \Gamma, \delta, q_0, q_{accept}, q_{reject})$ the **computation** of M on a string w over Σ is:

- Read/write head starts at leftmost position on tape.
- Input string is written on $|w|$ -many leftmost cells of tape, rest of the tape cells have the blank symbol. **Tape alphabet** is Γ with $\sqcup \in \Gamma$ and $\Sigma \subseteq \Gamma$. The blank symbol $\sqcup \notin \Sigma$.
- Given current state of machine and current symbol being read at the tape head, the machine transitions to next state, writes a symbol to the current position of the tape head (overwriting existing symbol), and moves the tape head L or R (if possible). Formally, **transition function** is

$$\delta : Q \times \Gamma \rightarrow Q \times \Gamma \times \{L, R\}$$

- Computation ends if and when machine enters either the accept or the reject state. This is called **halting**. Note: $q_{accept} \neq q_{reject}$.

The **language recognized by the Turing machine** M , is

$$\{w \in \Sigma^* \mid \text{computation of } M \text{ on } w \text{ halts after entering the accept state}\} = \{w \in \Sigma^* \mid w \text{ is accepted by } M\}$$

To define a Turing machine, we could give a

- **Formal definition**, namely the 7-tuple of parameters including set of states, input alphabet, tape alphabet, transition function, start state, accept state, and reject state; or,
- **Implementation-level definition**: English prose that describes the Turing machine head movements relative to contents of tape, and conditions for accepting / rejecting based on those contents.

Conventions for drawing state diagrams of Turing machines: (1) omit the reject state from the diagram (unless it's the start state), (2) any missing transitions in the state diagram have value (q_{reject}, \sqcup, R) .

A language L is **recognized by** a Turing machine M means



A Turing machine M **recognizes** a language L if means

A Turing machine M is a **decider** means

A language L is **decided by** a Turing machine M means

A Turing machine M **decides** a language L means

Fix $\Sigma = \{0, 1\}$, $\Gamma = \{0, 1, \sqcup\}$ for the Turing machines with the following state diagrams:

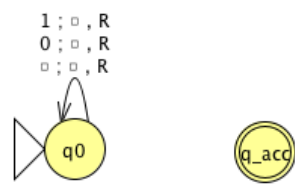
 <p>Implementation level description:</p> <p>Example of string accepted: Example of string rejected:</p> <p>Decider? Yes / No</p>	 <p>Implementation level description:</p> <p>Example of string accepted: Example of string rejected:</p> <p>Decider? Yes / No</p>
 <p>Implementation level description:</p> <p>Example of string accepted: Example of string rejected:</p> <p>Decider? Yes / No</p>	 <p>Implementation level description:</p> <p>Example of string accepted: Example of string rejected:</p> <p>Decider? Yes / No</p>

Week6 wednesday

Two models of computation are called **equally expressive** when every language recognizable with the first model is recognizable with the second, and vice versa.

True / False: NFAs and PDAs are equally expressive.

True / False: Regular expressions and CFGs are equally expressive.

*Some examples of models that are **equally expressive** with deterministic Turing machines:*

May-stay machines The May-stay machine model is the same as the usual Turing machine model, except that on each transition, the tape head may move L, move R, or Stay.

Formally: $(Q, \Sigma, \Gamma, \delta, q_0, q_{accept}, q_{reject})$ where

$$\delta : Q \times \Gamma \rightarrow Q \times \Gamma \times \{L, R, S\}$$

Claim: Turing machines and May-stay machines are equally expressive. *To prove ...*

To translate a standard TM to a may-stay machine:

To translate one of the may-stay machines to standard TM: any time TM would Stay, move right then left.

Formally: suppose $M_S = (Q, \Sigma, \Gamma, \delta, q_0, q_{acc}, q_{rej})$ has $\delta : Q \times \Gamma \rightarrow Q \times \Gamma \times \{L, R, S\}$. Define the Turing-machine

$$M_{new} = (\quad)$$

Multitape Turing machine A multitape Turing machine with k tapes can be formally represented as $(Q, \Sigma, \Gamma, \delta, q_0, q_{acc}, q_{rej})$ where Q is the finite set of states, Σ is the input alphabet with $\sqcup \notin \Sigma$, Γ is the tape alphabet with $\Sigma \subsetneq \Gamma$, $\delta : Q \times \Gamma^k \rightarrow Q \times \Gamma^k \times \{L, R\}^k$ (where k is the number of tapes)

If M is a standard TM, it is a 1-tape machine.

To translate a k -tape machine to a standard TM: Use a new symbol to separate the contents of each tape and keep track of location of head with special version of each tape symbol. Sipser Theorem 3.13

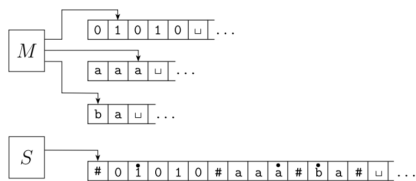

FIGURE 3.14 Representing three tapes with one

Extra practice: **Wikipedia Turing machine** Define a machine $(Q, \Gamma, b, \Sigma, q_0, F, \delta)$ where Q is the finite set of states, Γ is the tape alphabet, $b \in \Gamma$ is the blank symbol, $\Sigma \subsetneq \Gamma$ is the input alphabet, $q_0 \in Q$ is the start state, $F \subseteq Q$ is the set of accept states, $\delta : (Q \setminus F) \times \Gamma \rightarrow Q \times \Gamma \times \{L, R\}$ is a partial transition function. If computation enters a state in F , it accepts. If computation enters a configuration where δ is not defined, it rejects. Hopcroft and Ullman, cited by Wikipedia

Week6 friday

To define a Turing machine, we could give a

- **Formal definition:** the 7-tuple of parameters including set of states, input alphabet, tape alphabet, transition function, start state, accept state, and reject state; or,
- **Implementation-level definition:** English prose that describes the Turing machine head movements relative to contents of tape, and conditions for accepting / rejecting based on those contents.
- **High-level description:** description of algorithm (precise sequence of instructions), without implementation details of machine. As part of this description, can “call” and run another TM as a subroutine.

Theorem 3.21 A language is Turing-recognizable iff some enumerator enumerates it.

Proof:

Assume L is enumerated by some enumerator, E , so $L = L(E)$. We'll use E in a subroutine within a high-level description of a new Turing machine that we will build to recognize L .

Goal: build Turing machine M_E with $L(M_E) = L(E)$.

Define M_E as follows: $M_E =$ “On input w ,

1. Run E . For each string x printed by E .
2. Check if $x = w$. If so, accept (and halt); otherwise, continue.”

Assume L is Turing-recognizable and there is a Turing machine M with $L = L(M)$. We'll use M in a subroutine within a high-level description of an enumerator that we will build to enumerate L .

Goal: build enumerator E_M with $L(E_M) = L(M)$.

Idea: check each string in turn to see if it is in L .

How? Run computation of M on each string. *But:* need to be careful about computations that don't halt.

Recall String order for $\Sigma = \{0, 1\}$: $s_1 = \varepsilon$, $s_2 = 0$, $s_3 = 1$, $s_4 = 00$, $s_5 = 01$, $s_6 = 10$, $s_7 = 11$, $s_8 = 000$, ...

Define E_M as follows: $E_M =$ “ignore any input. Repeat the following for $i = 1, 2, 3, \dots$

1. Run the computations of M on s_1, s_2, \dots, s_i for (at most) i steps each
2. For each of these i computations that accept during the (at most) i steps, print out the accepted string.”

Nondeterministic Turing machine

At any point in the computation, the nondeterministic machine may proceed according to several possibilities: $(Q, \Sigma, \Gamma, \delta, q_0, q_{acc}, q_{rej})$ where

$$\delta : Q \times \Gamma \rightarrow \mathcal{P}(Q \times \Gamma \times \{L, R\})$$

The computation of a nondeterministic Turing machine is a tree with branching when the next step of the computation has multiple possibilities. A nondeterministic Turing machine accepts a string exactly when some branch of the computation tree enters the accept state.

Given a nondeterministic machine, we can use a 3-tape Turing machine to simulate it by doing a breadth-first search of computation tree: one tape is “read-only” input tape, one tape simulates the tape of the nondeterministic computation, and one tape tracks nondeterministic branching. Sipser page 178

Two models of computation are called **equally expressive** when every language recognizable with the first model is recognizable with the second, and vice versa.

Church-Turing Thesis (Sipser p. 183): The informal notion of algorithm is formalized completely and correctly by the formal definition of a Turing machine. In other words: all reasonably expressive models of computation are equally expressive with the standard Turing machine.

Claim: If two languages (over a fixed alphabet Σ) are Turing-recognizable, then their union is as well.

Proof using Turing machines:

Proof using nondeterministic Turing machines:

Proof using enumerators:

Week7 monday

	Suppose M is a TM that recognizes L	Suppose D is a TM that decides L	Suppose E is an enumerator that enumerates L
If string w is in L then ...			
If string w is not in L then ...			

Describing Turing machines (Sipser p. 185)

The Church-Turing thesis posits that each algorithm can be implemented by some Turing machine

High-level descriptions of Turing machine algorithms are written as indented text within quotation marks.

Stages of the algorithm are typically numbered consecutively.

The first line specifies the input to the machine, which must be a string. This string may be the encoding of some object or list of objects.

Notation: $\langle O \rangle$ is the string that encodes the object O . $\langle O_1, \dots, O_n \rangle$ is the string that encodes the list of objects O_1, \dots, O_n .

Assumption: There are Turing machines that can be called as subroutines to decode the string representations of common objects and interact with these objects as intended (data structures).

A **computational problem** is decidable iff language encoding its positive problem instances is decidable.

The computational problem “Does a specific DFA accept a given string?” is encoded by the language

$$\begin{aligned} & \{\text{representations of DFAs } M \text{ and strings } w \text{ such that } w \in L(M)\} \\ = & \{\langle M, w \rangle \mid M \text{ is a DFA, } w \text{ is a string, } w \in L(M)\} \end{aligned}$$

The computational problem “Is the language generated by a CFG empty?” is encoded by the language

$$\begin{aligned} & \{\text{representations of CFGs } G \text{ such that } L(G) = \emptyset\} \\ = & \{\langle G \rangle \mid G \text{ is a CFG, } L(G) = \emptyset\} \end{aligned}$$

The computational problem “Is the given Turing machine a decider?” is encoded by the language

$$\begin{aligned} & \{\text{representations of TMs } M \text{ such that } M \text{ halts on every input}\} \\ = & \{\langle M \rangle \mid M \text{ is a TM and for each string } w, M \text{ halts on } w\} \end{aligned}$$

Note: writing down the language encoding a computational problem is only the first step in determining if it's recognizable, decidable, or ...

Some classes of computational problems help us understand the differences between the machine models we've been studying:

Acceptance problem		
... for DFA	A_{DFA}	$\{\langle B, w \rangle \mid B \text{ is a DFA that accepts input string } w\}$
... for NFA	A_{NFA}	$\{\langle B, w \rangle \mid B \text{ is a NFA that accepts input string } w\}$
... for regular expressions	A_{REX}	$\{\langle R, w \rangle \mid R \text{ is a regular expression that generates input string } w\}$
... for CFG	A_{CFG}	$\{\langle G, w \rangle \mid G \text{ is a context-free grammar that generates input string } w\}$
... for PDA	A_{PDA}	$\{\langle B, w \rangle \mid B \text{ is a PDA that accepts input string } w\}$
Language emptiness testing		
... for DFA	E_{DFA}	$\{\langle A \rangle \mid A \text{ is a DFA and } L(A) = \emptyset\}$
... for NFA	E_{NFA}	$\{\langle A \rangle \mid A \text{ is a NFA and } L(A) = \emptyset\}$
... for regular expressions	E_{REX}	$\{\langle R \rangle \mid R \text{ is a regular expression and } L(R) = \emptyset\}$
... for CFG	E_{CFG}	$\{\langle G \rangle \mid G \text{ is a context-free grammar and } L(G) = \emptyset\}$
... for PDA	E_{PDA}	$\{\langle A \rangle \mid A \text{ is a PDA and } L(A) = \emptyset\}$
Language equality testing		
... for DFA	EQ_{DFA}	$\{\langle A, B \rangle \mid A \text{ and } B \text{ are DFAs and } L(A) = L(B)\}$
... for NFA	EQ_{NFA}	$\{\langle A, B \rangle \mid A \text{ and } B \text{ are NFAs and } L(A) = L(B)\}$
... for regular expressions	EQ_{REX}	$\{\langle R, R' \rangle \mid R \text{ and } R' \text{ are regular expressions and } L(R) = L(R')\}$
... for CFG	EQ_{CFG}	$\{\langle G, G' \rangle \mid G \text{ and } G' \text{ are CFGs and } L(G) = L(G')\}$
... for PDA	EQ_{PDA}	$\{\langle A, B \rangle \mid A \text{ and } B \text{ are PDAs and } L(A) = L(B)\}$
Sipser Section 4.1		

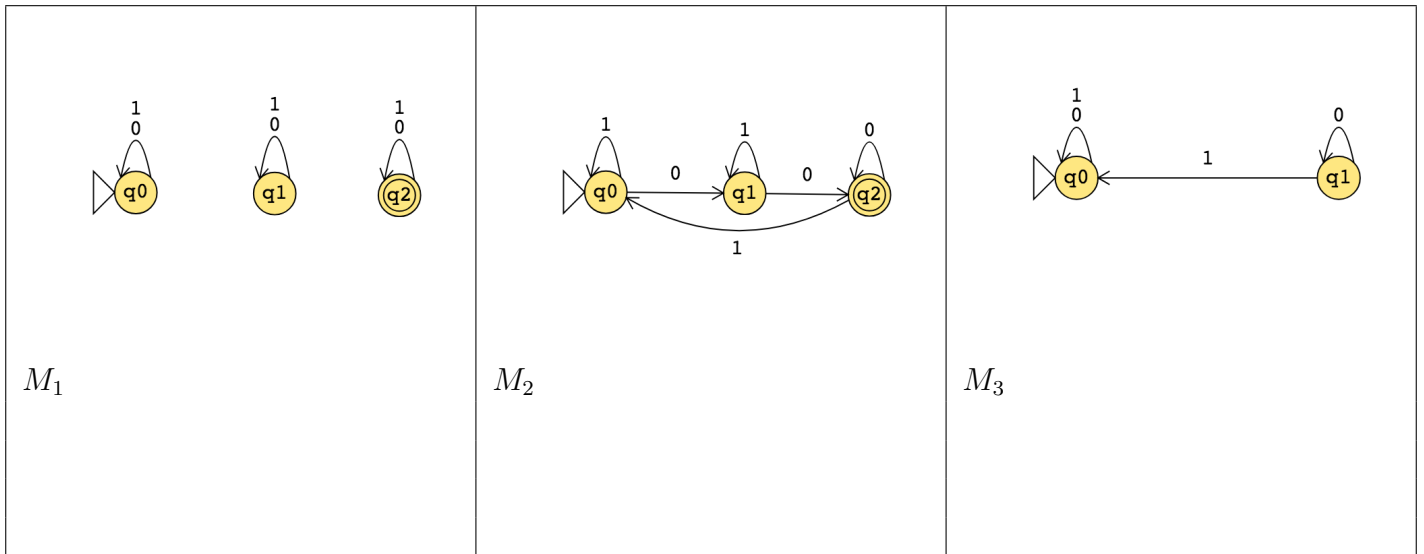

Example strings in A_{DFA}

Example strings in E_{DFA}

Example strings in EQ_{DFA}

Food for thought: which of the following computational problems are decidable: A_{DFA} ?, E_{DFA} ?, EQ_{DFA} ?

Week7 wednesday

Deciding a computational problem means building / defining a Turing machine that recognizes the language encoding the computational problem, and that is a decider.

Acceptance problem for ... $A...$ $\{\langle B, w \rangle \mid B \text{ is a } \dots \text{ that accepts input string } w\}$
Language emptiness testing for ... $E...$ $\{\langle A \rangle \mid A \text{ is a } \dots \text{ and } L(A) = \emptyset\}$
Language equality testing for ... $EQ...$ $\{\langle A, B \rangle \mid A \text{ and } B \text{ are } \dots \text{ and } L(A) = L(B)\}$
Sipser Section 4.1

$M_1 =$ “On input $\langle M, w \rangle$, where M is a DFA and w is a string:

0. Type check encoding to check input is correct type.
1. Simulate M on input w (by keeping track of states in M , transition function of M , etc.)
2. If the simulations ends in an accept state of M , accept. If it ends in a non-accept state of M , reject. ”

What is $L(M_1)$?

Is $L(M_1)$ a decider?

$M_2 =$ “On input $\langle M, w \rangle$ where M is a DFA and w is a string,

1. Run M on input w .
2. If M accepts, accept; if M rejects, reject.”

What is $L(M_2)$?

Is M_2 a decider?

$A_{REX} =$

$A_{NFA} =$

True / False: $A_{REX} = A_{NFA} = A_{DFA}$

True / False: $A_{REX} \cap A_{NFA} = \emptyset$, $A_{REX} \cap A_{DFA} = \emptyset$, $A_{DFA} \cap A_{NFA} = \emptyset$

A Turing machine that decides A_{NFA} is:

A Turing machine that decides A_{REX} is:

$M_3 =$ “On input $\langle M \rangle$ where M is a DFA,

1. For integer $i = 1, 2, \dots$
2. Let s_i be the i th string over the alphabet of M (ordered in string order).
3. Run M on input s_i .
4. If M accepts, _____ . If M rejects, increment i and keep going.”

Choose the correct option to help fill in the blank so that M_3 recognizes E_{DFA}

- A. accepts
- B. rejects
- C. loop for ever
- D. We can't fill in the blank in any way to make this work
- E. None of the above

$M_4 =$ “ On input $\langle M \rangle$ where M is a DFA,

1. Mark the start state of M .
2. Repeat until no new states get marked:
3. Loop over the states of M .
4. Mark any unmarked state that has an incoming edge from a marked state.
5. If no accept state of A is marked, _____; otherwise, _____”.

To build a Turing machine that decides EQ_{DFA} , notice that

$$L_1 = L_2 \quad \text{iff} \quad ((L_1 \cap \overline{L_2}) \cup (L_2 \cap \overline{L_1})) = \emptyset$$

There are no elements that are in one set and not the other

$M_{EQDFA} =$

Summary: We can use the decision procedures (Turing machines) of decidable problems as subroutines in other algorithms. For example, we have subroutines for deciding each of A_{DFA} , E_{DFA} , EQ_{DFA} . We can also use algorithms for known constructions as subroutines in other algorithms. For example, we have subroutines for: counting the number of states in a state diagram, counting the number of characters in an alphabet, converting DFA to a DFA recognizing the complement of the original language or a DFA recognizing the Kleene star of the original language, constructing a DFA or NFA from two DFA or NFA so that we have a machine recognizing the language of the union (or intersection, concatenation) of the languages of the original machines; converting regular expressions to equivalent DFA; converting DFA to equivalent regular expressions, etc.

Week7 friday

Acceptance problem

... for DFA	A_{DFA}	$\{\langle B, w \rangle \mid B \text{ is a DFA that accepts input string } w\}$
... for NFA	A_{NFA}	$\{\langle B, w \rangle \mid B \text{ is a NFA that accepts input string } w\}$
... for regular expressions	A_{REX}	$\{\langle R, w \rangle \mid R \text{ is a regular expression that generates input string } w\}$
... for CFG	A_{CFG}	$\{\langle G, w \rangle \mid G \text{ is a context-free grammar that generates input string } w\}$
... for PDA	A_{PDA}	$\{\langle B, w \rangle \mid B \text{ is a PDA that accepts input string } w\}$

Acceptance problemfor Turing machines $A_{TM} \{ \langle M, w \rangle \mid M \text{ is a Turing machine that accepts input string } w \}$ **Language emptiness testing**for Turing machines $E_{TM} \{ \langle M \rangle \mid M \text{ is a Turing machine and } L(M) = \emptyset \}$ **Language equality testing**for Turing machines $EQ_{TM} \{ \langle M_1, M_2 \rangle \mid M_1 \text{ and } M_2 \text{ are Turing machines and } L(M_1) = L(M_2) \}$

Sipser Section 4.1

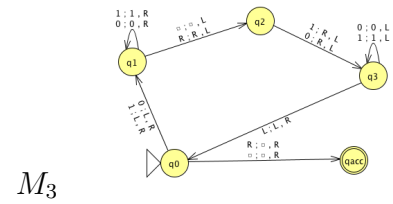
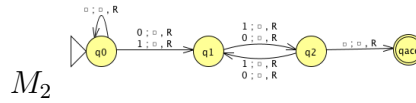
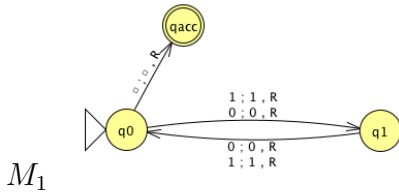
Example strings in A_{TM} Example strings in E_{TM} Example strings in EQ_{TM}

Theorem: A_{TM} is Turing-recognizable.

Strategy: To prove this theorem, we need to define a Turing machine R_{ATM} such that $L(R_{ATM}) = A_{TM}$.

Define $R_{ATM} =$ “

Proof of correctness:

We will show that A_{TM} is undecidable. *First, let's explore what that means.*

A **Turing-recognizable** language is a set of strings that is the language recognized by some Turing machine. We also say that such languages are recognizable.

A **Turing-decidable** language is a set of strings that is the language recognized by some decider. We also say that such languages are decidable.

An **unrecognizable** language is a language that is not Turing-recognizable.

An **undecidable** language is a language that is not Turing-decidable.

True or False: Any undecidable language is also unrecognizable.

True or False: Any unrecognizable language is also undecidable.

To prove that a computational problem is **decidable**, we find/ build a Turing machine that recognizes the language encoding the computational problem, and that is a decider.

How do we prove a specific problem is **not decidable**?

How would we even find such a computational problem?

Counting arguments for the existence of an undecidable language:

- The set of all Turing machines is countably infinite.
- Each Turing-recognizable language is associated with a Turing machine in a one-to-one relationship, so there can be no more Turing-recognizable languages than there are Turing machines.
- Since there are infinitely many Turing-recognizable languages (think of the singleton sets), there are countably infinitely many Turing-recognizable languages.
- Such the set of Turing-decidable languages is an infinite subset of the set of Turing-recognizable languages, the set of Turing-decidable languages is also countably infinite.

Since there are uncountably many languages (because $\mathcal{P}(\Sigma^*)$ is uncountable), there are uncountably many unrecognizable languages and there are uncountably many undecidable languages.

Thus, there's at least one undecidable language!

What's a specific example of a language that is unrecognizable or undecidable?

To prove that a language is undecidable, we need to prove that there is no Turing machine that decides it.

Key idea: proof by contradiction relying on self-referential disagreement.

Week3 friday

Theorem: For an alphabet Σ , For each language L over Σ ,

L is recognized by some DFA
iff
 L is recognized by some NFA
iff
 L is described by some regular expression

If (any, hence all) these conditions apply, L is called **regular**.

Prove or Disprove: There is some alphabet Σ for which there is some language recognized by an NFA but not by any DFA.

Prove or Disprove: There is some alphabet Σ for which there is some finite language not described by any regular expression over Σ .

Prove or Disprove: If a language is recognized by an NFA then the complement of this language is not recognized by any DFA.

Set	Cardinality
$\{0, 1\}$	
$\{0, 1\}^*$	
$\mathcal{P}(\{0, 1\})$	
The set of all languages over $\{0, 1\}$	
The set of all regular expressions over $\{0, 1\}$	
The set of all regular languages over $\{0, 1\}$	

Pumping Lemma (Sipser Theorem 1.70): If A is a regular language, then there is a number p (a *pumping length*) where, if s is any string in A of length at least p , then s may be divided into three pieces, $s = xyz$ such that

- $|y| > 0$
- for each $i \geq 0$, $xy^iz \in A$
- $|xy| \leq p$.

True or False: A pumping length for $A = \{0, 1\}^*$ is $p = 5$.

True or False: A pumping length for $A = \{1, 01, 001, 0001, 00001\}$ is $p = 4$.

True or False: A pumping length for $A = \{0^j1 \mid j \geq 0\}$ is $p = 3$.

True or False: For any language A , if p is a pumping length for A and $p' > p$, then p' is also a pumping length for A .