

Week5 monday

Warmup: Design a CFG to generate the language $\{a^i b^j \mid j \geq i \geq 0\}$

Sample derivation:

Design a PDA to recognize the language $\{a^i b^j \mid j \geq i \geq 0\}$

Theorem 2.20: A language is generated by some context-free grammar if and only if it is recognized by some push-down automaton.

Definition: a language is called **context-free** if it is the language generated by a context-free grammar. The class of all context-free language over a given alphabet Σ is called **CFL**.

Consequences:

- Quick proof that every regular language is context free
- To prove closure of the class of context-free languages under a given operation, we can choose either of two modes of proof (via CFGs or PDAs) depending on which is easier
- To fully specify a PDA we could give its 6-tuple formal definition or we could give its input alphabet, stack alphabet, and state diagram. An informal description of a PDA is a step-by-step description of how its computations would process input strings; the reader should be able to reconstruct the state diagram or formal definition precisely from such a description. The informal description of a PDA can refer to some common modules or subroutines that are computable by PDAs:
 - PDAs can “test for emptiness of stack” without providing details. *How?* We can always push a special end-of-stack symbol, $\$$, at the start, before processing any input, and then use this symbol as a flag.
 - PDAs can “test for end of input” without providing details. *How?* We can transform a PDA to one where accepting states are only those reachable when there are no more input symbols.

Suppose L_1 and L_2 are context-free languages over Σ . **Goal:** $L_1 \cup L_2$ is also context-free.

Approach 1: with PDAs

Let $M_1 = (Q_1, \Sigma, \Gamma_1, \delta_1, q_1, F_1)$ and $M_2 = (Q_2, \Sigma, \Gamma_2, \delta_2, q_2, F_2)$ be PDAs with $L(M_1) = L_1$ and $L(M_2) = L_2$.

Define $M =$

Approach 2: with CFGs

Let $G_1 = (V_1, \Sigma, R_1, S_1)$ and $G_2 = (V_2, \Sigma, R_2, S_2)$ be CFGs with $L(G_1) = L_1$ and $L(G_2) = L_2$.

Define $G =$

Suppose L_1 and L_2 are context-free languages over Σ . **Goal:** $L_1 \circ L_2$ is also context-free.

Approach 1: with PDAs

Let $M_1 = (Q_1, \Sigma, \Gamma_1, \delta_1, q_1, F_1)$ and $M_2 = (Q_2, \Sigma, \Gamma_2, \delta_2, q_2, F_2)$ be PDAs with $L(M_1) = L_1$ and $L(M_2) = L_2$.

Define $M =$

Approach 2: with CFGs

Let $G_1 = (V_1, \Sigma, R_1, S_1)$ and $G_2 = (V_2, \Sigma, R_2, S_2)$ be CFGs with $L(G_1) = L_1$ and $L(G_2) = L_2$.

Define $G =$

Week5 wednesday

Summary

Over a fixed alphabet Σ , a language L is **regular**

iff it is described by some regular expression

iff it is recognized by some DFA

iff it is recognized by some NFA

Over a fixed alphabet Σ , a language L is **context-free**

iff it is generated by some CFG

iff it is recognized by some PDA

Fact: Every regular language is a context-free language.

Fact: There are context-free languages that are not nonregular.

Fact: There are countably many regular languages.

Fact: There are countably infinitely many context-free languages.

Consequence: Most languages are **not** context-free!

Examples of non-context-free languages

$$\{a^n b^n c^n \mid 0 \leq n, n \in \mathbb{Z}\}$$

$$\{a^i b^j c^k \mid 0 \leq i \leq j \leq k, i \in \mathbb{Z}, j \in \mathbb{Z}, k \in \mathbb{Z}\}$$

$$\{ww \mid w \in \{0, 1\}^*\}$$

(Sipser Ex 2.36, Ex 2.37, 2.38)

There is a Pumping Lemma for CFL that can be used to prove a specific language is non-context-free: If A is a context-free language, there is a number p where, if s is any string in A of length at least p , then s may be divided into five pieces $s = uvxyz$ where (1) for each $i \geq 0$, $uv^i xy^i z \in A$, (2) $|uv| > 0$, (3) $|vxy| \leq p$. *We will not go into the details of the proof or application of Pumping Lemma for CFLs this quarter.*

Recall: A set X is said to be **closed** under an operation OP if, for any elements in X , applying OP to them gives an element in X .

True/False	Closure claim
True	The set of integers is closed under multiplication. $\forall x \forall y ((x \in \mathbb{Z} \wedge y \in \mathbb{Z}) \rightarrow xy \in \mathbb{Z})$
True	For each set A , the power set of A is closed under intersection. $\forall A_1 \forall A_2 ((A_1 \in \mathcal{P}(A) \wedge A_2 \in \mathcal{P}(A)) \rightarrow A_1 \cap A_2 \in \mathcal{P}(A))$
	The class of regular languages over Σ is closed under complementation.
	The class of regular languages over Σ is closed under union.
	The class of regular languages over Σ is closed under intersection.
	The class of regular languages over Σ is closed under concatenation.
	The class of regular languages over Σ is closed under Kleene star.
	The class of context-free languages over Σ is closed under complementation.
	The class of context-free languages over Σ is closed under union.
	The class of context-free languages over Σ is closed under intersection.
	The class of context-free languages over Σ is closed under concatenation.
	The class of context-free languages over Σ is closed under Kleene star.

Week5 friday

We are ready to introduce a formal model that will capture a notion of general purpose computation.

- *Similar to DFA, NFA, PDA*: input will be an arbitrary string over a fixed alphabet.
- *Different from NFA, PDA*: machine is deterministic.
- *Different from DFA, NFA, PDA*: read-write head can move both to the left and to the right, and can extend to the right past the original input.
- *Similar to DFA, NFA, PDA*: transition function drives computation one step at a time by moving within a finite set of states, always starting at designated start state.
- *Different from DFA, NFA, PDA*: the special states for rejecting and accepting take effect immediately.

(See more details: Sipser p. 166)

Formally: a Turing machine is $M = (Q, \Sigma, \Gamma, \delta, q_0, q_{accept}, q_{reject})$ where δ is the **transition function**

$$\delta : Q \times \Gamma \rightarrow Q \times \Gamma \times \{L, R\}$$

The **computation** of M on a string w over Σ is:

- Read/write head starts at leftmost position on tape.
- Input string is written on $|w|$ -many leftmost cells of tape, rest of the tape cells have the blank symbol. **Tape alphabet** is Γ with $\sqcup \in \Gamma$ and $\Sigma \subseteq \Gamma$. The blank symbol $\sqcup \notin \Sigma$.
- Given current state of machine and current symbol being read at the tape head, the machine transitions to next state, writes a symbol to the current position of the tape head (overwriting existing symbol), and moves the tape head L or R (if possible).
- Computation ends **if and when** machine enters either the accept or the reject state. This is called **halting**. Note: $q_{accept} \neq q_{reject}$.

The **language recognized by the Turing machine** M , is $L(M) = \{w \in \Sigma^* \mid w \text{ is accepted by } M\}$, which is defined as

$$\{w \in \Sigma^* \mid \text{computation of } M \text{ on } w \text{ halts after entering the accept state}\}$$

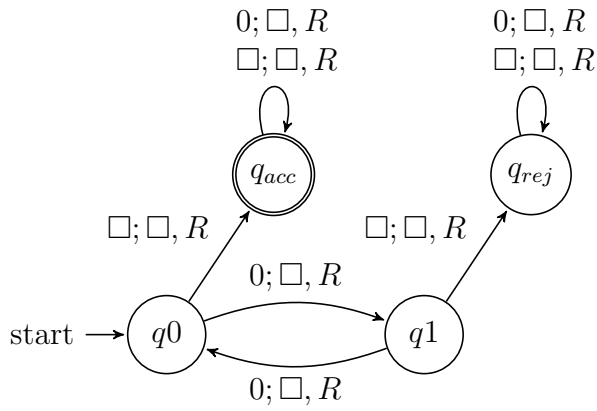

Formal

definition:

Sample computation:

$q0 \downarrow$						
0	0	0	□	□	□	□

The language recognized by this machine is ...

Describing Turing machines (Sipser p. 185) To define a Turing machine, we could give a

- **Formal definition:** the 7-tuple of parameters including set of states, input alphabet, tape alphabet, transition function, start state, accept state, and reject state; or,
- **Implementation-level definition:** English prose that describes the Turing machine head movements relative to contents of tape, and conditions for accepting / rejecting based on those contents.
- **High-level description:** description of algorithm (precise sequence of instructions), without implementation details of machine. As part of this description, can “call” and run another TM as a subroutine.

Fix $\Sigma = \{0, 1\}$, $\Gamma = \{0, 1, _ \}$ for the Turing machines with the following state diagrams:

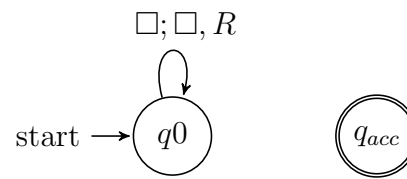

Example of string accepted:

Example of string rejected:

Implementation-level description

High-level description



Example of string accepted:

Example of string rejected:

Implementation-level description

High-level description

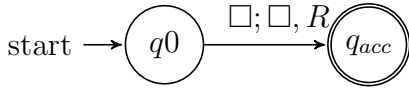

Example of string accepted:

Example of string rejected:

Implementation-level description

High-level description

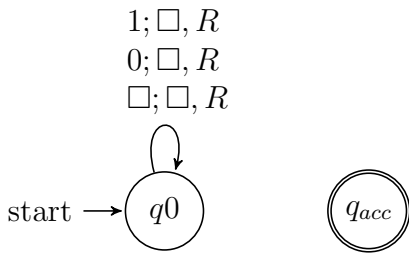

Example of string accepted:

Example of string rejected:

Implementation-level description

High-level description

Week4 monday

Regular sets are not the end of the story

- Many nice / simple / important sets are not regular
- Limitation of the finite-state automaton model: Can't "count", Can only remember finitely far into the past, Can't backtrack, Must make decisions in "real-time"
- We know actual computers are more powerful than this model...

The **next** model of computation. Idea: allow some memory of unbounded size. How?

- To generalize regular expressions: **context-free grammars**
- To generalize NFA: **Pushdown automata**, which is like an NFA with access to a stack: Number of states is fixed, number of entries in stack is unbounded. At each step (1) Transition to new state based on current state, letter read, and top letter of stack, then (2) (Possibly) push or pop a letter to (or from) top of stack. Accept a string iff there is some sequence of states and some sequence of stack contents which helps the PDA processes the entire input string and ends in an accepting state.

Is there a PDA that recognizes the nonregular language $\{0^n 1^n \mid n \geq 0\}$?

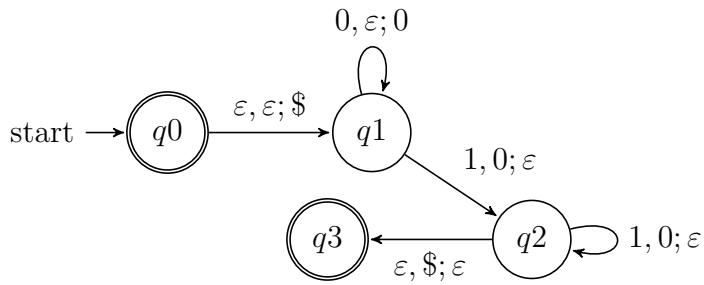

The PDA with state diagram above can be informally described as:

Read symbols from the input. As each 0 is read, push it onto the stack. As soon as 1s are seen, pop a 0 off the stack for each 1 read. If the stack becomes empty and we are at the end of the input string, accept the input. If the stack becomes empty and there are 1s left to read, or if 1s are finished while the stack still contains 0s, or if any 0s appear in the string following 1s, reject the input.

Trace the computation of this PDA on the input string 01.

Trace the computation of this PDA on the input string 011.

A PDA recognizing the set $\{ \text{ } \}$ can be informally described as:

Read symbols from the input. As each 0 is read, push it onto the stack. As soon as 1s are seen, pop a 0 off the stack for each 1 read. If the stack becomes empty and there is exactly one 1 left to read, read that 1 and accept the input. If the stack becomes empty and there are either zero or more than one 1s left to read, or if the 1s are finished while the stack still contains 0s, or if any 0s appear in the input following 1s, reject the input.

Modify the state diagram below to get a PDA that implements this description:

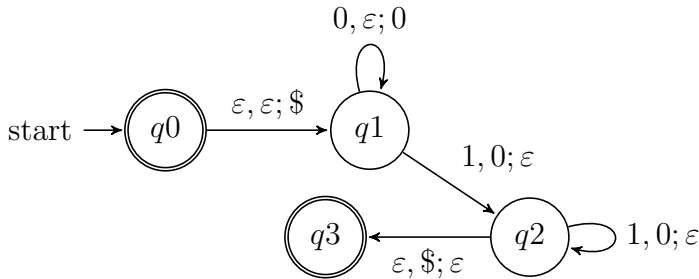

Week4 wednesday

Definition A **pushdown automaton** (PDA) is specified by a 6-tuple $(Q, \Sigma, \Gamma, \delta, q_0, F)$ where Q is the finite set of states, Σ is the input alphabet, Γ is the stack alphabet,

$$\delta : Q \times \Sigma_\epsilon \times \Gamma_\epsilon \rightarrow \mathcal{P}(Q \times \Gamma_\epsilon)$$

is the transition function, $q_0 \in Q$ is the start state, $F \subseteq Q$ is the set of accept states.

Draw the state diagram and give the formal definition of a PDA with $\Sigma = \Gamma$.

Draw the state diagram and give the formal definition of a PDA with $\Sigma \cap \Gamma = \emptyset$.

For the PDA state diagrams below, $\Sigma = \{0, 1\}$.

Mathematical description of language

State diagram of PDA recognizing language

$\Gamma = \{\$, \#\}$

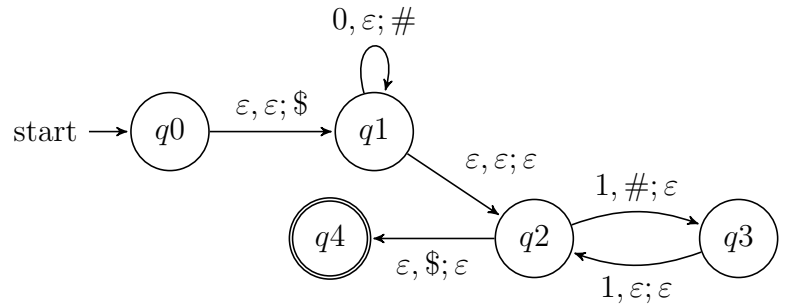

$\Gamma = \{\ast, 1\}$

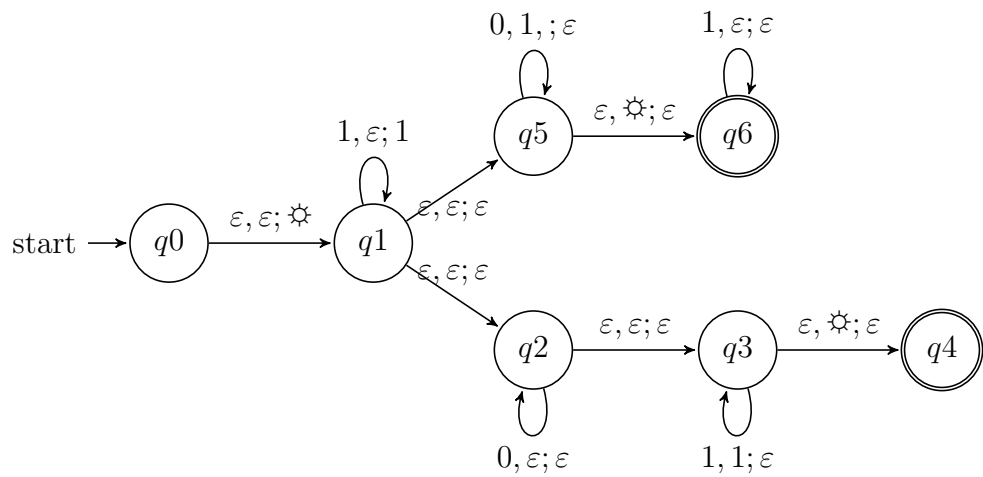

$\{0^i 1^j 0^k \mid i, j, k \geq 0\}$

Note: alternate notation is to replace ; with \rightarrow

A language L is **recognized by** a Turing machine M means

A Turing machine M **recognizes** a language L means

A Turing machine M is a **decider** means

A language L is **decided by** a Turing machine M means

A Turing machine M **decides** a language L means

Fix $\Sigma = \{0, 1\}$, $\Gamma = \{0, 1, \sqcup\}$ for the Turing machines with the following state diagrams:

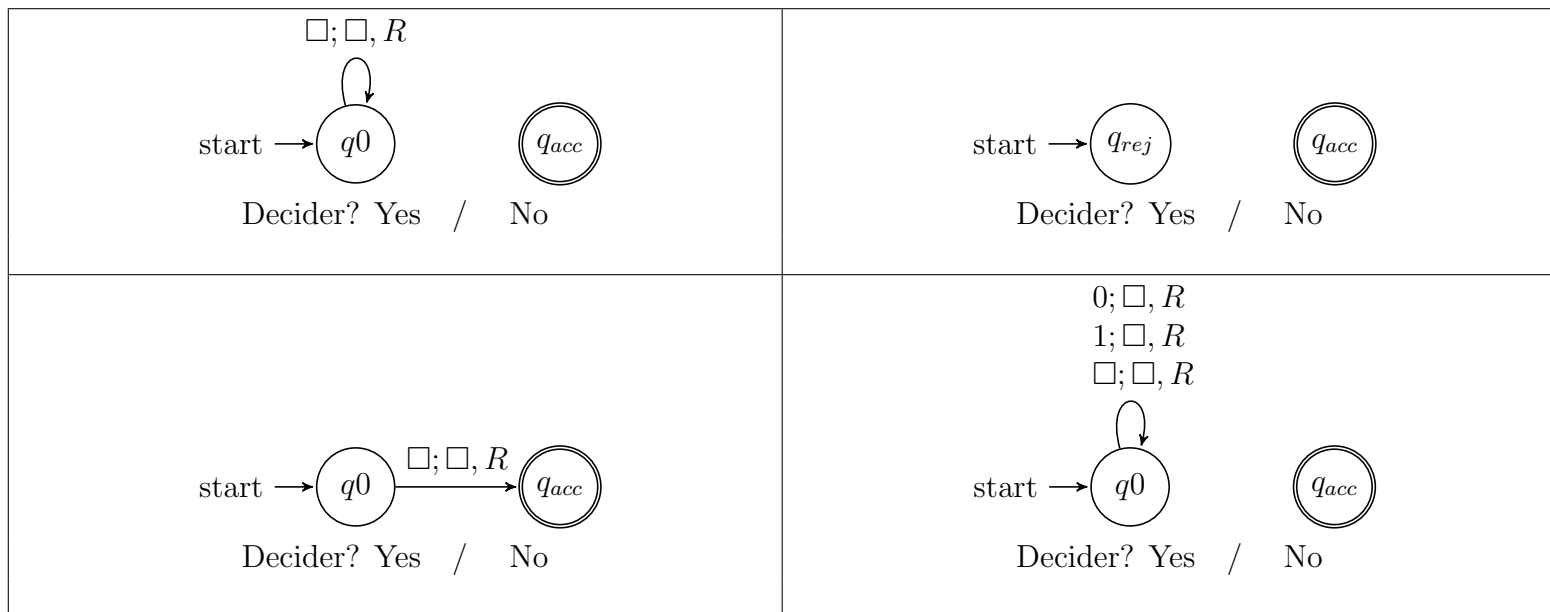

Week6 wednesday

A **Turing-recognizable** language is a set of strings that is the language recognized by some Turing machine. We also say that such languages are recognizable.

A **Turing-decidable** language is a set of strings that is the language recognized by some decider. We also say that such languages are decidable.

An **unrecognizable** language is a language that is not Turing-recognizable.

An **undecidable** language is a language that is not Turing-decidable.

True or False: Any decidable language is also recognizable.

True or False: Any recognizable language is also decidable.

True or False: Any undecidable language is also unrecognizable.

True or False: Any unrecognizable language is also undecidable.

True or False: The class of Turing-decidable languages is closed under complementation.

Using formal definition:

Using high-level description:

Church-Turing Thesis (Sipser p. 183): The informal notion of algorithm is formalized completely and correctly by the formal definition of a Turing machine. In other words: all reasonably expressive models of computation are equally expressive with the standard Turing machine.

Week6 friday

Definition: A language L over an alphabet Σ is called **co-recognizable** if its complement, defined as $\Sigma^* \setminus L = \{x \in \Sigma^* \mid x \notin L\}$, is Turing-recognizable.

Theorem (Sipser Theorem 4.22): A language is Turing-decidable if and only if both it and its complement are Turing-recognizable.

Proof, first direction: Suppose language L is Turing-decidable. WTS that both it and its complement are Turing-recognizable.

Proof, second direction: Suppose language L is Turing-recognizable, and so is its complement. WTS that L is Turing-decidable.

Notation: The complement of a set X is denoted with a superscript c , X^c , or an overline, \overline{X} .

Claim: If two languages (over a fixed alphabet Σ) are Turing-decidable, then their union is as well.

Proof:

Claim: If two languages (over a fixed alphabet Σ) are Turing-recognizable, then their union is as well.

Proof:

Week3 monday

So far we have that:

- If there is a DFA recognizing a language, there is a DFA recognizing its complement.
- If there are NFA recognizing two languages, there is a NFA recognizing their union.
- If there are DFA recognizing two languages, there is a DFA recognizing their union.
- If there are DFA recognizing two languages, there is a DFA recognizing their intersection.

Our goals for today are (1) prove similar results about other set operations, (2) prove that NFA and DFA are equally expressive, and therefore (3) define an important class of languages.

Suppose A_1, A_2 are languages over an alphabet Σ . **Claim:** if there is a NFA N_1 such that $L(N_1) = A_1$ and NFA N_2 such that $L(N_2) = A_2$, then there is another NFA, let's call it N , such that $L(N) = A_1 \circ A_2$.

Proof idea: Allow computation to move between N_1 and N_2 “spontaneously” when reach an accepting state of N_1 , guessing that we've reached the point where the two parts of the string in the set-wise concatenation are glued together.

Formal construction: Let $N_1 = (Q_1, \Sigma, \delta_1, q_1, F_1)$ and $N_2 = (Q_2, \Sigma, \delta_2, q_2, F_2)$ and assume $Q_1 \cap Q_2 = \emptyset$. Construct $N = (Q, \Sigma, \delta, q_0, F)$ where

- $Q =$
- $q_0 =$
- $F =$
- $\delta : Q \times \Sigma_\varepsilon \rightarrow \mathcal{P}(Q)$ is defined by, for $q \in Q$ and $a \in \Sigma_\varepsilon$:

$$\delta((q, a)) = \begin{cases} \delta_1((q, a)) & \text{if } q \in Q_1 \text{ and } q \notin F_1 \\ \delta_1((q, a)) & \text{if } q \in F_1 \text{ and } a \in \Sigma \\ \delta_1((q, a)) \cup \{q_2\} & \text{if } q \in F_1 \text{ and } a = \varepsilon \\ \delta_2((q, a)) & \text{if } q \in Q_2 \end{cases}$$

Proof of correctness would prove that $L(N) = A_1 \circ A_2$ by considering an arbitrary string accepted by N , tracing an accepting computation of N on it, and using that trace to prove the string can be written as the result of concatenating two strings, the first in A_1 and the second in A_2 ; then, taking an arbitrary string in $A_1 \circ A_2$ and proving that it is accepted by N . Details left for extra practice.

Suppose A is a language over an alphabet Σ . **Claim:** if there is a NFA N such that $L(N) = A$, then there is another NFA, let's call it N' , such that $L(N') = A^*$.

Proof idea: Add a fresh start state, which is an accept state. Add spontaneous moves from each (old) accept state to the old start state.

Formal construction: Let $N = (Q, \Sigma, \delta, q_1, F)$ and assume $q_0 \notin Q$. Construct $N' = (Q', \Sigma, \delta', q_0, F')$ where

- $Q' = Q \cup \{q_0\}$
- $F' = F \cup \{q_0\}$
- $\delta' : Q' \times \Sigma_\varepsilon \rightarrow \mathcal{P}(Q')$ is defined by, for $q \in Q'$ and $a \in \Sigma_\varepsilon$:

$$\delta'((q, a)) = \begin{cases} \delta((q, a)) & \text{if } q \in Q \text{ and } q \notin F \\ \delta((q, a)) & \text{if } q \in F \text{ and } a \in \Sigma \\ \delta((q, a)) \cup \{q_1\} & \text{if } q \in F \text{ and } a = \varepsilon \\ \{q_1\} & \text{if } q = q_0 \text{ and } a = \varepsilon \\ \emptyset & \text{if } q = q_0 \text{ and } a \in \Sigma \end{cases}$$

Proof of correctness would prove that $L(N') = A^$ by considering an arbitrary string accepted by N' , tracing an accepting computation of N' on it, and using that trace to prove the string can be written as the result of concatenating some number of strings, each of which is in A ; then, taking an arbitrary string in A^* and proving that it is accepted by N' . Details left for extra practice.*

Application: A state diagram for a NFA over $\Sigma = \{a, b\}$ that recognizes $L((a^*b)^*)$:

Suppose A is a language over an alphabet Σ . **Claim:** if there is a NFA N such that $L(N) = A$ then there is a DFA M such that $L(M) = A$.

Proof idea: States in M are “macro-states” – collections of states from N – that represent the set of possible states a computation of N might be in.

Formal construction: Let $N = (Q, \Sigma, \delta, q_0, F)$. Define

$$M = (\mathcal{P}(Q), \Sigma, \delta', q', \{X \subseteq Q \mid X \cap F \neq \emptyset\})$$

where $q' = \{q \in Q \mid q = q_0 \text{ or is accessible from } q_0 \text{ by spontaneous moves in } N\}$ and

$\delta'((X, x)) = \{q \in Q \mid q \in \delta(r, x) \text{ for some } r \in X \text{ or is accessible from such an } r \text{ by spontaneous moves in } N\}$

Consider the state diagram of an NFA over $\{a, b\}$. Use the “macro-state” construction to find an equivalent DFA.

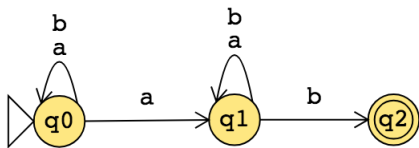

Consider the state diagram of an NFA over $\{0, 1\}$. Use the “macro-state” construction to find an equivalent DFA.

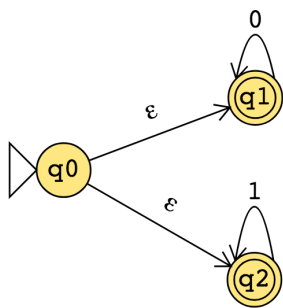

Note: We can often prune the DFAs that result from the “macro-state” constructions to get an equivalent DFA with fewer states (e.g. only the “macro-states” reachable from the start state).

The class of regular languages

Fix an alphabet Σ . For each language L over Σ :

There is a DFA over Σ that recognizes L $\exists M$ (M is a DFA and $L(M) = A$)
if and only if

There is a NFA over Σ that recognizes L $\exists N$ (N is a NFA and $L(N) = A$)
if and only if

There is a regular expression over Σ that describes L $\exists R$ (R is a regular expression and $L(R) = A$)

A language is called **regular** when any (hence all) of the above three conditions are met.

We already proved that DFAs and NFAs are equally expressive. It remains to prove that regular expressions are too.

Part 1: Suppose A is a language over an alphabet Σ . If there is a regular expression R such that $L(R) = A$, then there is a NFA, let's call it N , such that $L(N) = A$.

Structural induction: Regular expression is built from basis regular expressions using inductive steps (union, concatenation, Kleene star symbols). Use constructions to mirror these in NFAs.

Application: A state diagram for a NFA over $\{a, b\}$ that recognizes $L(a^*(ab)^*)$:

Part 2: Suppose A is a language over an alphabet Σ . If there is a DFA M such that $L(M) = A$, then there is a regular expression, let's call it R , such that $L(R) = A$.

Proof idea: Trace all possible paths from start state to accept state. Express labels of these paths as regular expressions, and union them all.

1. Add new start state with ε arrow to old start state.
2. Add new accept state with ε arrow from old accept states. Make old accept states non-accept.
3. Remove one (of the old) states at a time: modify regular expressions on arrows that went through removed state to restore language recognized by machine.

Application: Find a regular expression describing the language recognized by the DFA with state diagram

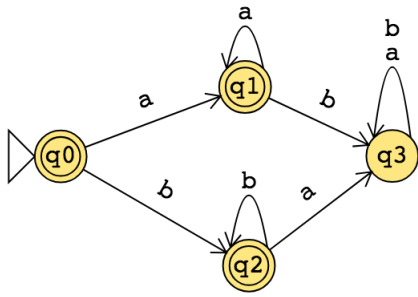

Week2 monday

Review: Formal definition of DFA: $M = (Q, \Sigma, \delta, q_0, F)$

- Finite set of states Q
- Alphabet Σ
- Transition function δ
- Start state q_0
- Accept (final) states F

Quick check: In the state diagram of M , how many outgoing arrows are there from each state?

Note: We'll see a new kind of finite automaton. It will be helpful to distinguish it from the machines we've been talking about so we'll use **Deterministic Finite Automaton** (DFA) to refer to the machines from Section 1.1.

$M = (\{q_0, q_1, q_2\}, \{a, b\}, \delta, q_0, \{q_0\})$ where δ is (rows labelled by states and columns labelled by symbols):

δ	a	b
q_0	q_1	q_1
q_1	q_2	q_2
q_2	q_0	q_0

The state diagram for M is

Give two examples of strings that are accepted by M and two examples of strings that are rejected by M :

A regular expression describing $L(M)$ is

A state diagram for a finite automaton recognizing

$$\{w \mid w \text{ is a string over } \{a, b\} \text{ whose length is not a multiple of } 3\}$$

Extra example: Let n be an arbitrary positive integer. What is a formal definition for a finite automaton recognizing

$$\{w \mid w \text{ is a string over } \{0, 1\} \text{ whose length is not a multiple of } n\}?$$

Consider the alphabet $\Sigma_1 = \{0, 1\}$.

A state diagram for a finite automaton that recognizes $\{w \mid w \text{ contains at most two 1's}\}$ is

A state diagram for a finite automaton that recognizes $\{w \mid w \text{ contains more than two 1's}\}$ is

Strategy: Add “labels” for states in the state diagram, e.g. “have not seen any of desired pattern yet” or “sink state”. Then, we can use the analysis of the roles of the states in the state diagram to work towards a description of the language recognized by the finite automaton.

Or: decompose the language to a simpler one that we already know how to recognize with a DFA or NFA.

Textbook Exercise 1.14: Suppose A is a language over an alphabet Σ . If there is a DFA M such that $L(M) = A$ then there is another DFA, let's call it M' , such that $L(M') = \overline{A}$, the complement of A , defined as $\{w \in \Sigma^* \mid w \notin A\}$.

Proof idea:

A useful bit of terminology: the **iterated transition function** of a finite automaton $M = (Q, \Sigma, \delta, q_0, F)$ is defined recursively by

$$\delta^*(q, w) = \begin{cases} q & \text{if } q \in Q, w = \varepsilon \\ \delta(q, a) & \text{if } q \in Q, w = a \in \Sigma \\ \delta(\delta^*(q, u), a) & \text{if } q \in Q, w = ua \text{ where } u \in \Sigma^* \text{ and } a \in \Sigma \end{cases}$$

Using this terminology, M accepts a string w over Σ if and only if $\delta^*(q_0, w) \in F$.

Proof:

Week2 wednesday

Nondeterministic finite automaton (Sipser Page 53) Given as $M = (Q, \Sigma, \delta, q_0, F)$

Finite set of states Q	Can be labelled by any collection of distinct names. Default: q_0, q_1, \dots
Alphabet Σ	Each input to the automaton is a string over Σ .
Arrow labels Σ_ϵ	$\Sigma_\epsilon = \Sigma \cup \{\epsilon\}$.
Transition function δ	Arrows in the state diagram are labelled either by symbols from Σ or by ϵ $\delta : Q \times \Sigma_\epsilon \rightarrow \mathcal{P}(Q)$ gives the set of possible next states for a transition from the current state upon reading a symbol or spontaneously moving.
Start state q_0	Element of Q . Each computation of the machine starts at the start state.
Accept (final) states F	$F \subseteq Q$.

M accepts the input string $w \in \Sigma^*$ if and only if **there is** a computation of M on w that processes the whole string and ends in an accept state.

The formal definition of the NFA over $\{0, 1\}$ given by this state diagram is:

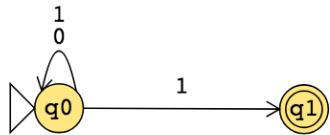

The language over $\{0, 1\}$ recognized by this NFA is:

Change the transition function to get a different NFA which accepts the empty string (and potentially other strings too).

The state diagram of an NFA over $\{a, b\}$ is below. The formal definition of this NFA is:

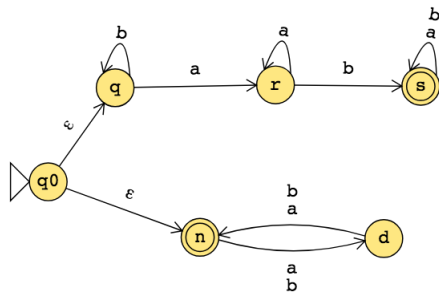

Suppose A_1, A_2 are languages over an alphabet Σ . **Claim:** if there is a NFA N_1 such that $L(N_1) = A_1$ and NFA N_2 such that $L(N_2) = A_2$, then there is another NFA, let's call it N , such that $L(N) = A_1 \cup A_2$.

Proof idea: Use nondeterminism to choose which of N_1, N_2 to run.

Formal construction: Let $N_1 = (Q_1, \Sigma, \delta_1, q_1, F_1)$ and $N_2 = (Q_2, \Sigma, \delta_2, q_2, F_2)$ and assume $Q_1 \cap Q_2 = \emptyset$ and that $q_0 \notin Q_1 \cup Q_2$. Construct $N = (Q, \Sigma, \delta, q_0, F_1 \cup F_2)$ where

- $Q =$
- $\delta : Q \times \Sigma_\epsilon \rightarrow \mathcal{P}(Q)$ is defined by, for $q \in Q$ and $x \in \Sigma_\epsilon$:

Proof of correctness would prove that $L(N) = A_1 \cup A_2$ by considering an arbitrary string accepted by N , tracing an accepting computation of N on it, and using that trace to prove the string is in at least one of A_1, A_2 ; then, taking an arbitrary string in $A_1 \cup A_2$ and proving that it is accepted by N . Details left for extra practice.

Week2 friday

Review: The language recognized by the NFA over $\{a, b\}$ with state diagram

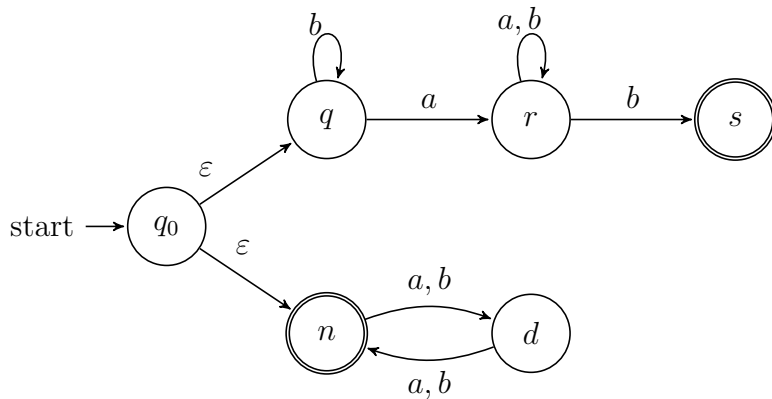

is:

So far, we know:

- The collection of languages that are each recognizable by a DFA is **closed** under complementation.
Could we do the same construction with NFA?

- The collection of languages that are each recognizable by a NFA is **closed** under union.
Could we do the same construction with DFA?

Happily, though, an analogous claim is true!

Suppose A_1, A_2 are languages over an alphabet Σ . **Claim:** if there is a DFA M_1 such that $L(M_1) = A_1$ and DFA M_2 such that $L(M_2) = A_2$, then there is another DFA, let's call it M , such that $L(M) = A_1 \cup A_2$.
Theorem 1.25 in Sipser, page 45

Proof idea:

Formal construction:

Example: When $A_1 = \{w \mid w \text{ has an } a \text{ and ends in } b\}$ and $A_2 = \{w \mid w \text{ is of even length}\}$.

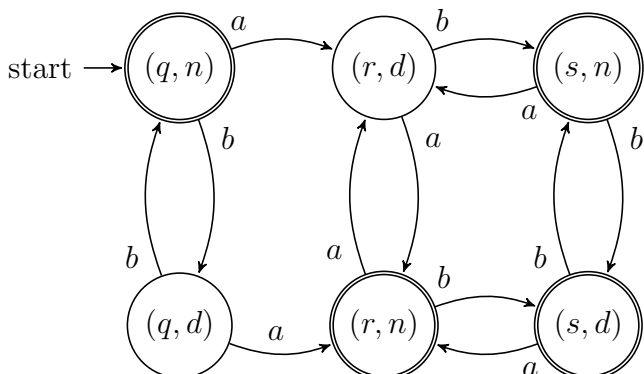

Suppose A_1, A_2 are languages over an alphabet Σ . **Claim:** if there is a DFA M_1 such that $L(M_1) = A_1$ and DFA M_2 such that $L(M_2) = A_2$, then there is another DFA, let's call it M , such that $L(M) = A_1 \cap A_2$.
Footnote to Sipser Theorem 1.25, page 46

Proof idea:

Formal construction:

Week1 friday

****This definition was in the pre-class reading**** A finite automaton (FA) is specified by $M = (Q, \Sigma, \delta, q_0, F)$. This 5-tuple is called the **formal definition** of the FA. The FA can also be represented by its state diagram: with nodes for the state, labelled edges specifying the transition function, and decorations on nodes denoting the start and accept states.

Finite set of states Q can be labelled by any collection of distinct names. Often we use default state labels q_0, q_1, \dots

The alphabet Σ determines the possible inputs to the automaton. Each input to the automaton is a string over Σ , and the automaton “processes” the input one symbol (or character) at a time.

The transition function δ gives the next state of the automaton based on the current state of the machine and on the next input symbol.

The start state q_0 is an element of Q . Each computation of the machine starts at the start state.

The accept (final) states F form a subset of the states of the automaton, $F \subseteq Q$. These states are used to flag if the machine accepts or rejects an input string.

The computation of a machine on an input string is a sequence of states in the machine, starting with the start state, determined by transitions of the machine as it reads successive input symbols.

The finite automaton M accepts the given input string exactly when the computation of M on the input string ends in an accept state. M rejects the given input string exactly when the computation of M on the input string ends in a nonaccept state, that is, a state that is not in F .

The language of M , $L(M)$, is defined as the set of all strings that are each accepted by the machine M . Each string that is rejected by M is not in $L(M)$. The language of M is also called the language recognized by M .

What is **finite** about all finite automata? (Select all that apply)

- The size of the machine (number of states, number of arrows)
- The length of each computation of the machine
- The number of strings that are accepted by the machine

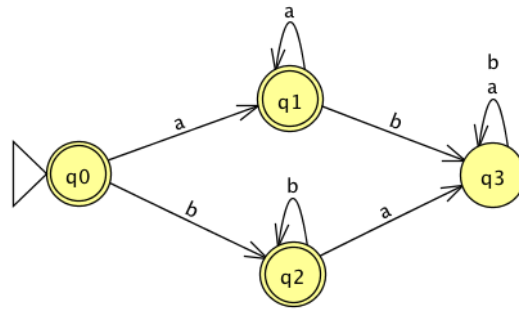

The formal definition of this FA is

Classify each string a , aa , ab , ba , bb , ε as accepted by the FA or rejected by the FA.

Why are these the only two options?

The language recognized by this automaton is

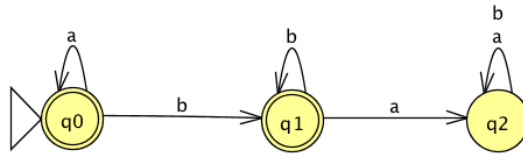

The language recognized by this automaton is

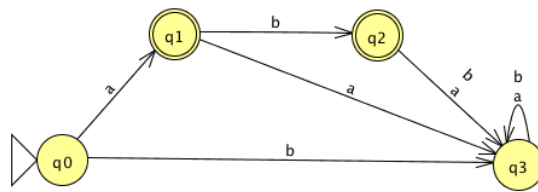

The language recognized by this automaton is